

SECCIÓN GENERAL. Mc6/Mc8/Mc9 Escala 1:5

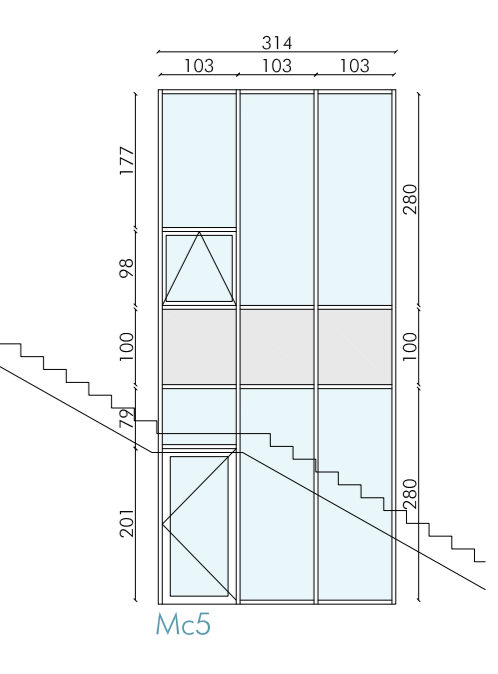

Escala 1:100

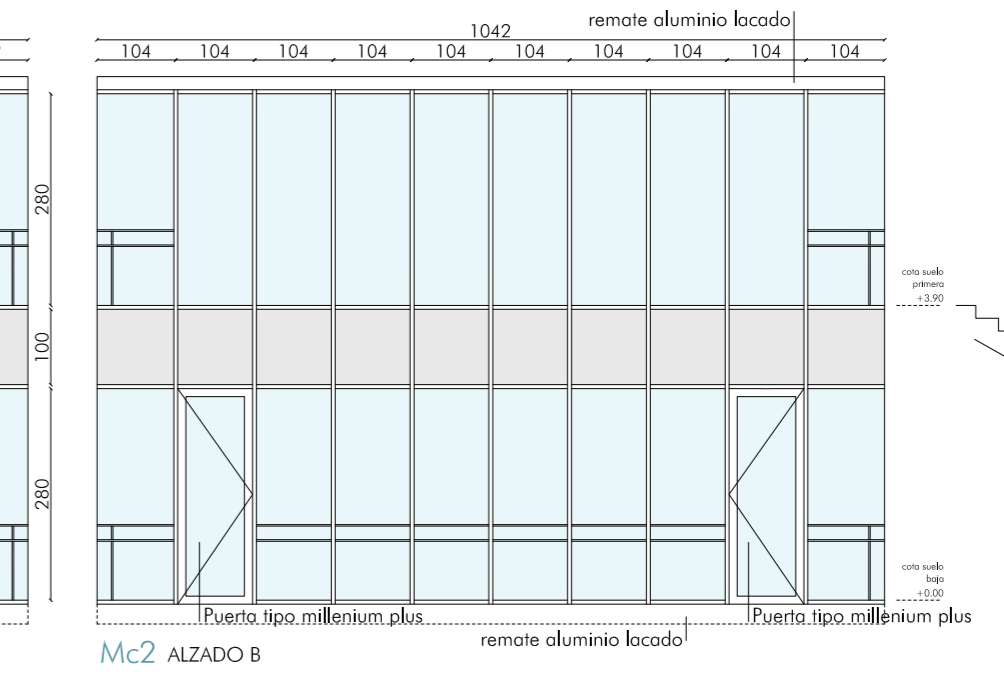
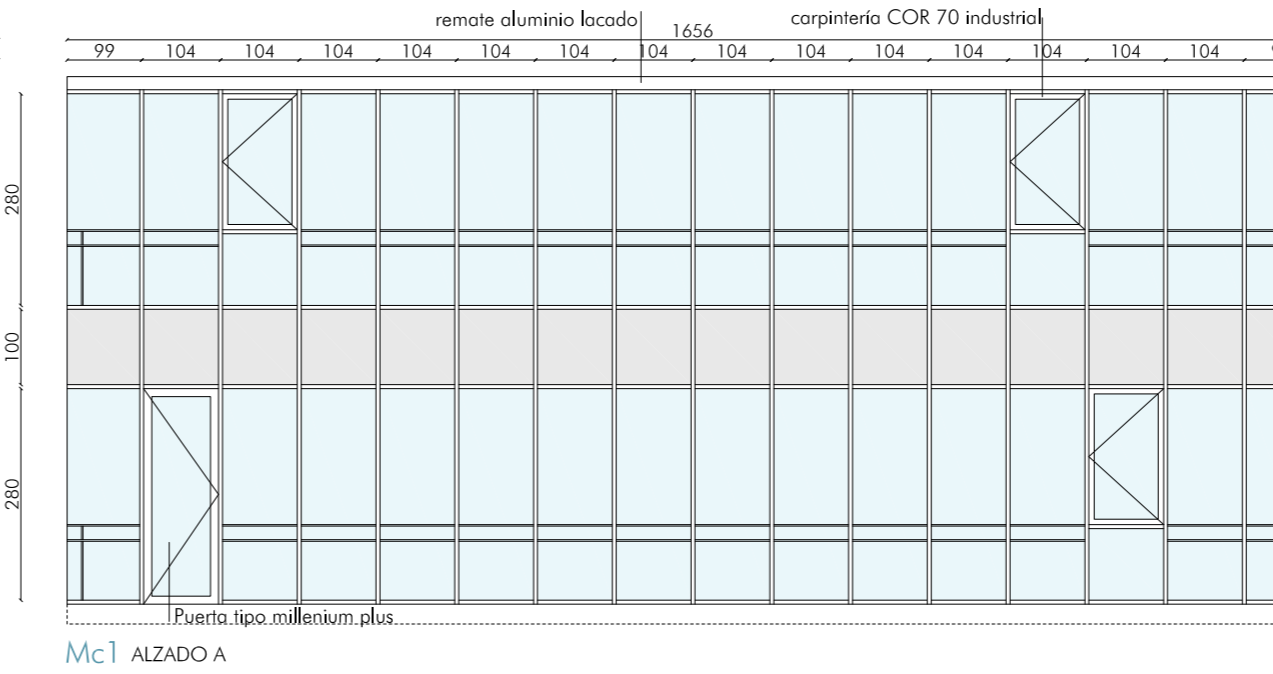
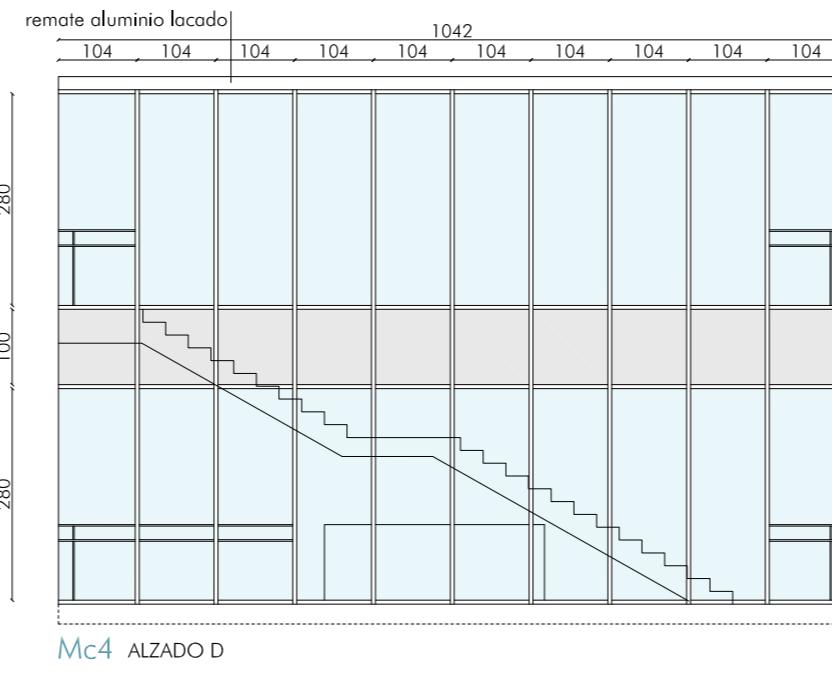
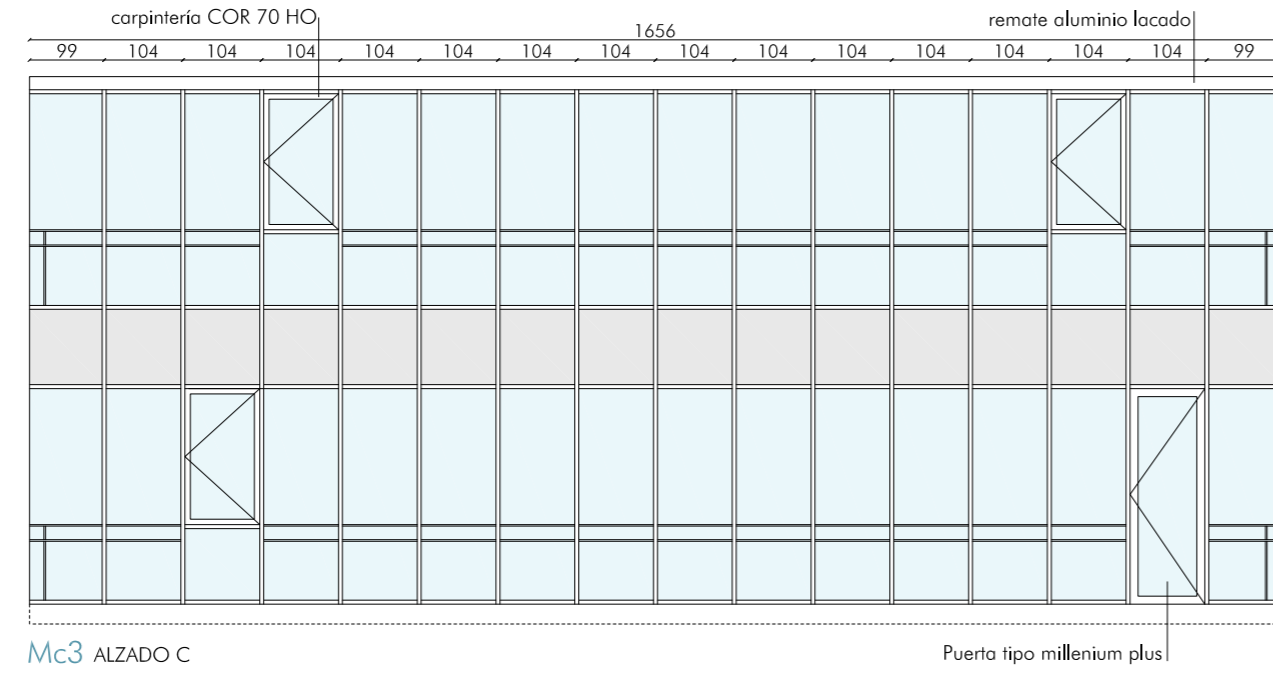
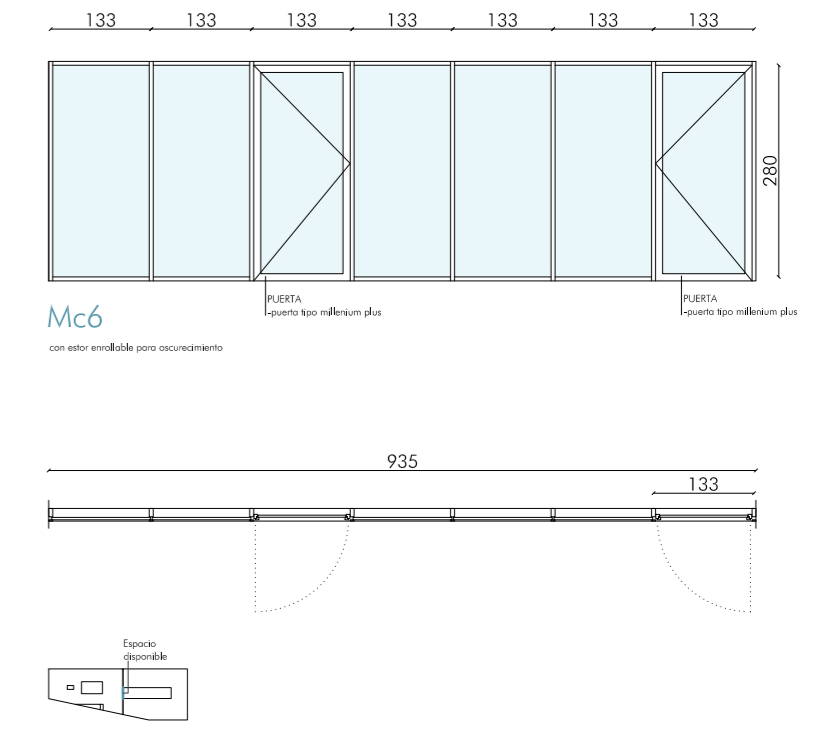
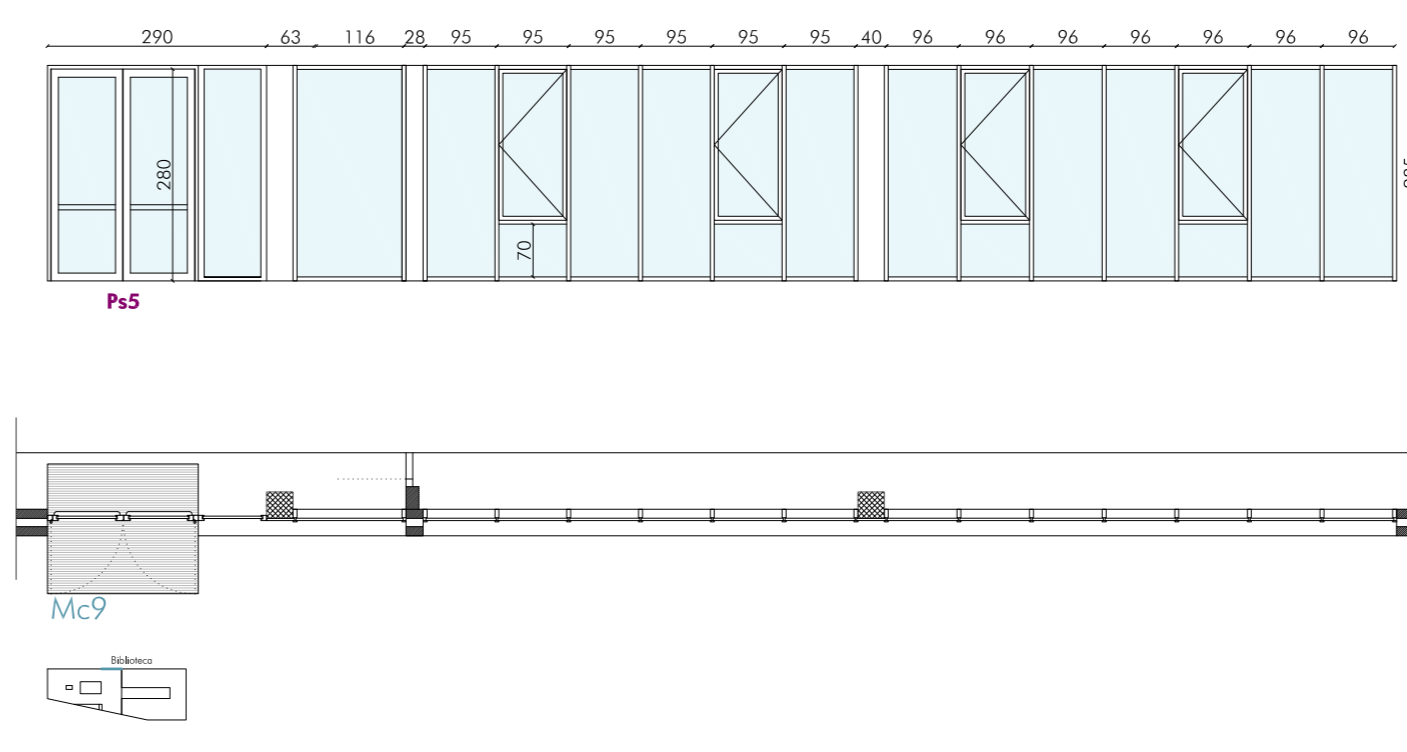
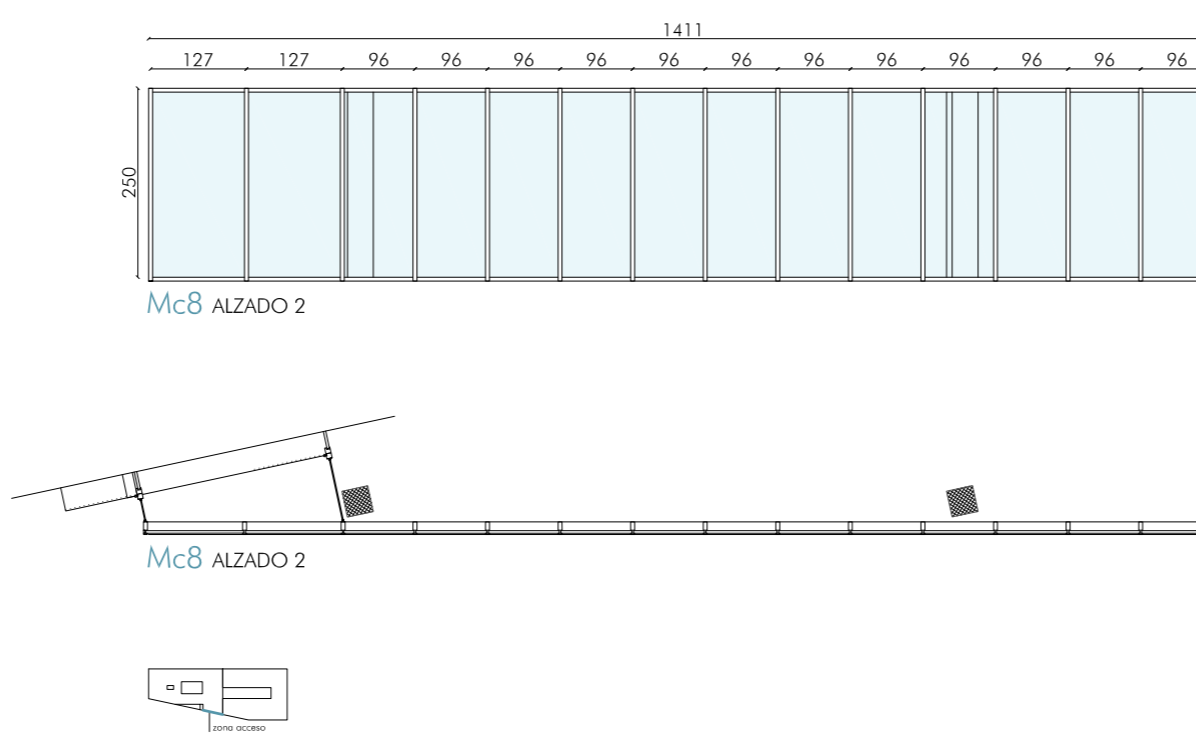
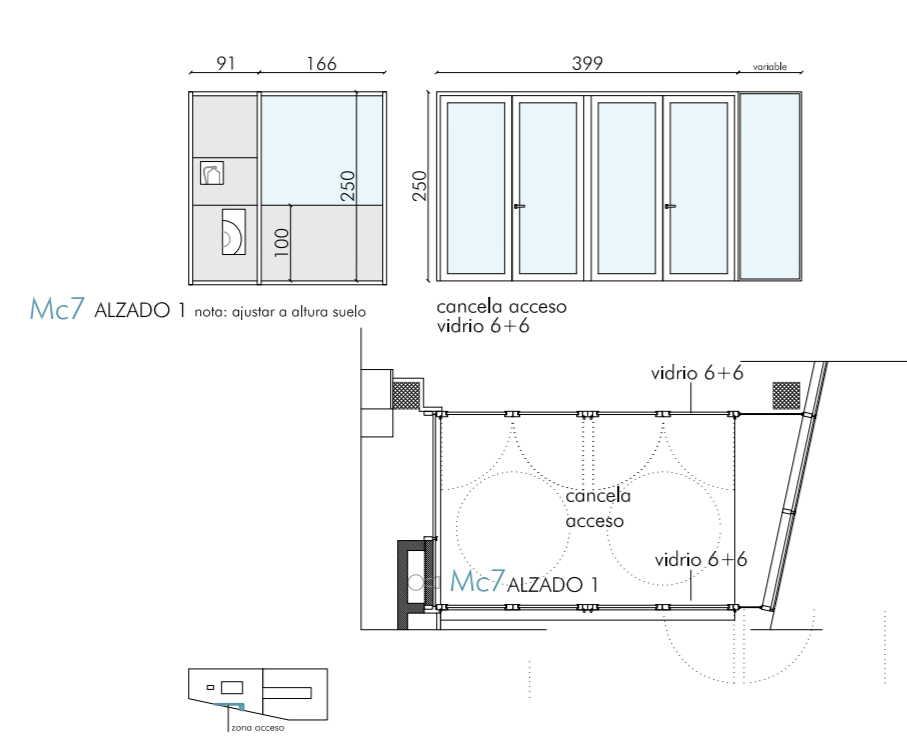
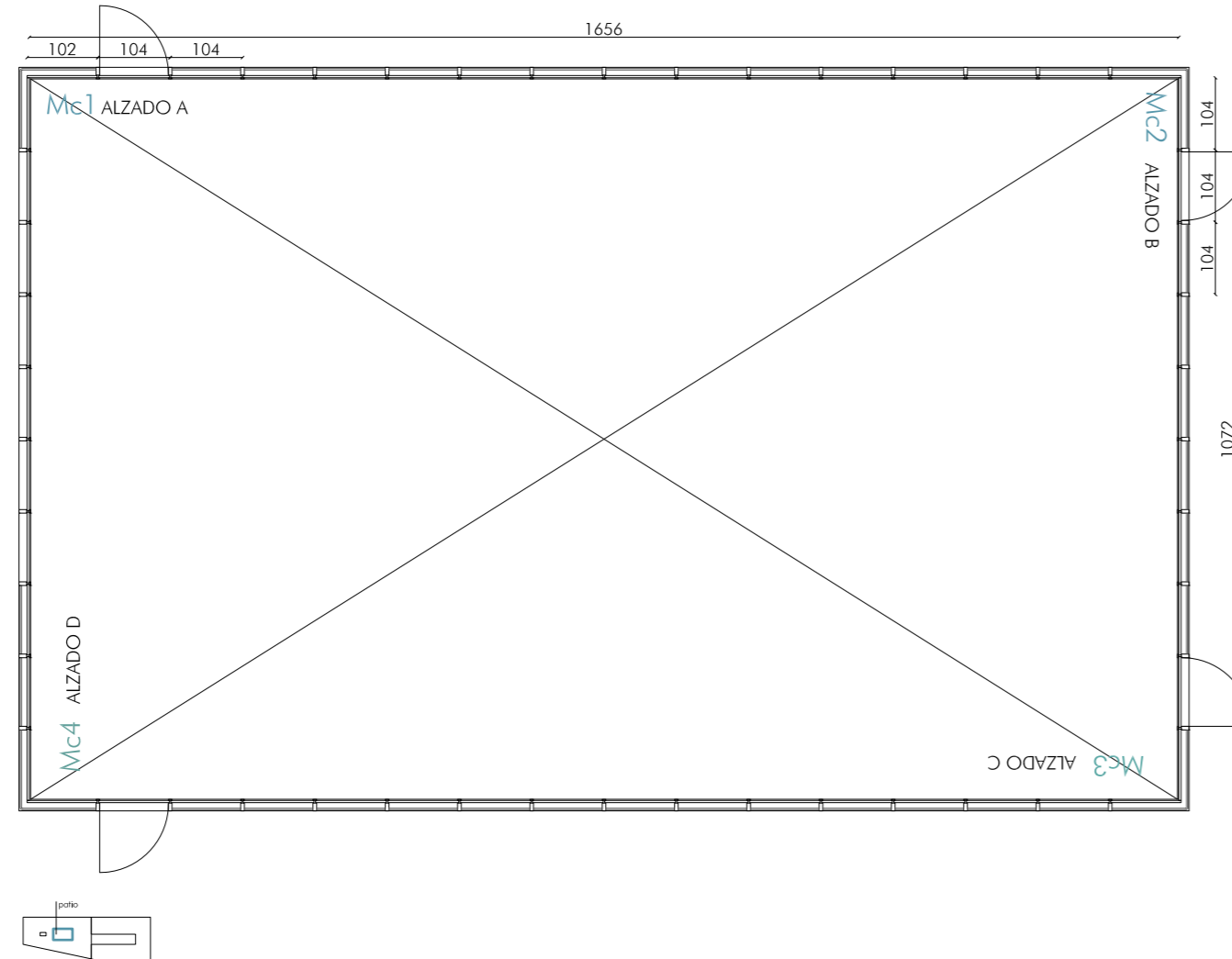

MEMORIA VENTANAS Y PUERTAS

TIPO: VENTANA	TIPO: PUERTA	TIPO: VENTANA	TIPO: PUERTA
LOCACION: sala de juntas	LOCACION: sala de juntas	LOCACION: sala de juntas	LOCACION: sala de juntas
UNIDADES: 4	UNIDADES: 2	UNIDADES: 2	UNIDADES: 2
NOTAS: No contar COR 70 hoja oculta	NOTAS: No contar COR 70 hoja oculta	NOTAS: No contar COR 70 hoja oculta	NOTAS: No contar COR 70 hoja oculta
VERBO: Nota Obra: instalar parrilla de aluminio	VERBO: Nota Obra: instalar parrilla de aluminio	VERBO: Nota Obra: instalar parrilla de aluminio	VERBO: Nota Obra: instalar parrilla de aluminio

Ps4: puerta tipo millenium plus, aluminio lacado

Ps5: puerta tipo millenium plus, aluminio lacado

Ps1: No contar millenium plus

Ps2: No contar millenium plus

Ps3: No contar millenium plus

Ps4: aluminio lacado

Ps5: aluminio lacado

Ps1: aluminio lacado

Ps2: aluminio lacado

Ps3: aluminio lacado

Ps4: aluminio lacado

Ps5: aluminio lacado

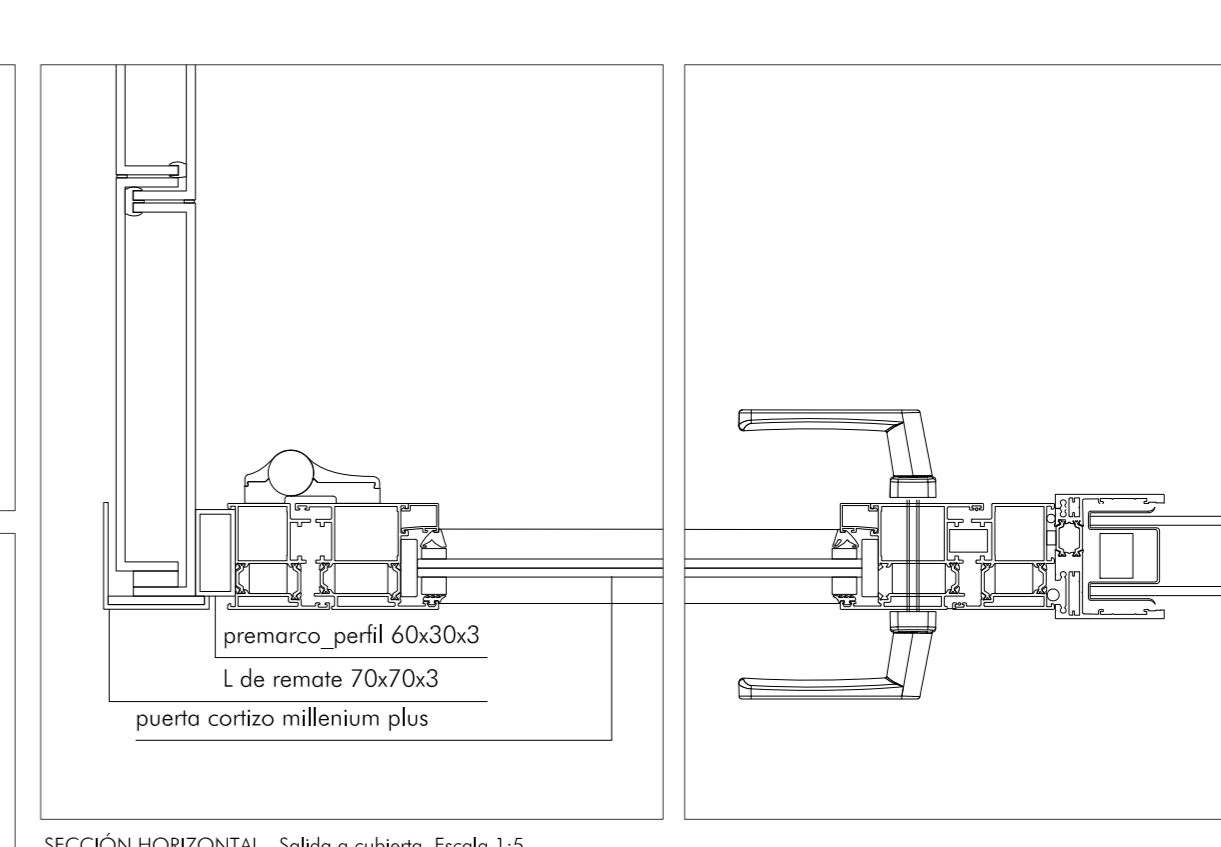
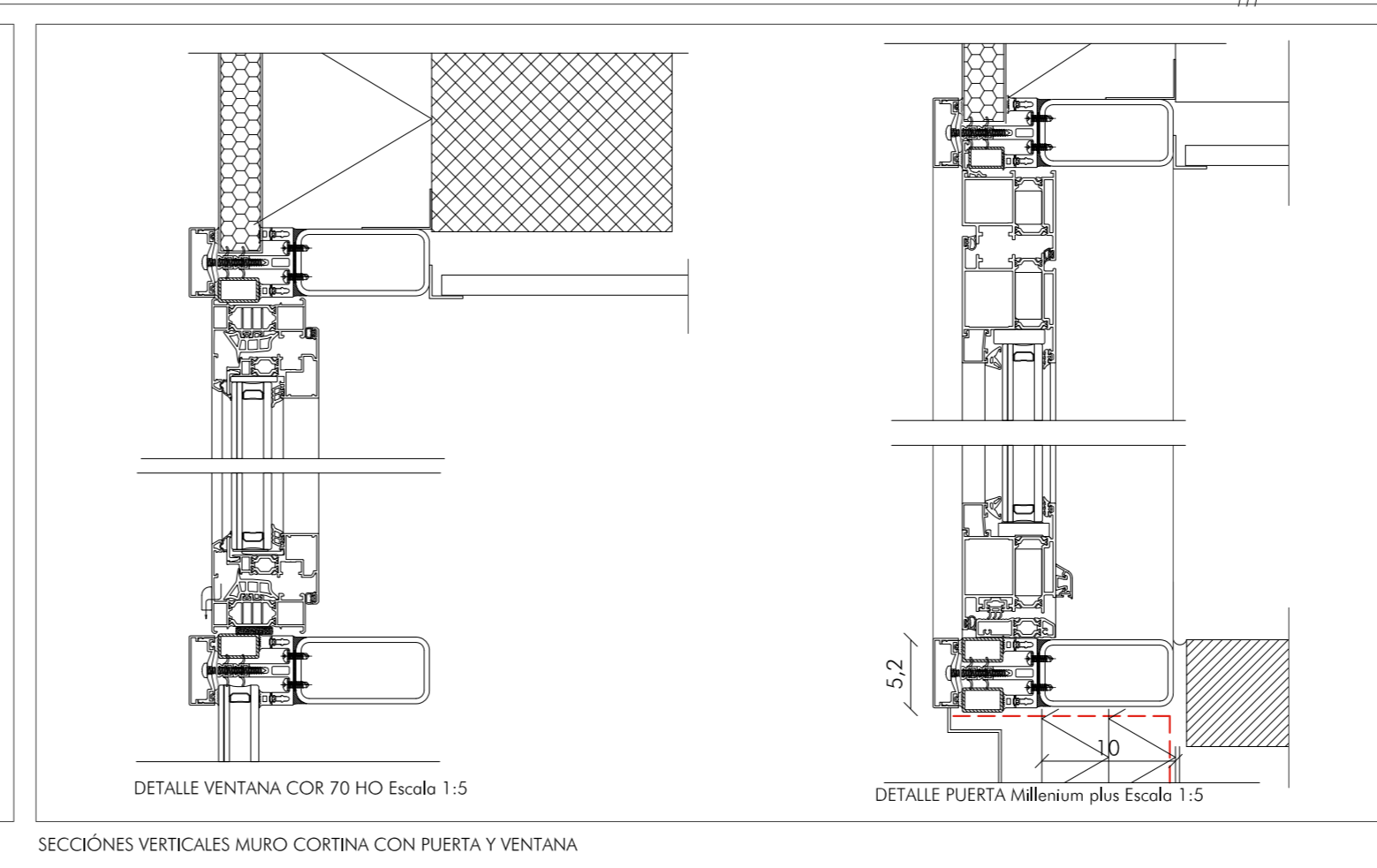
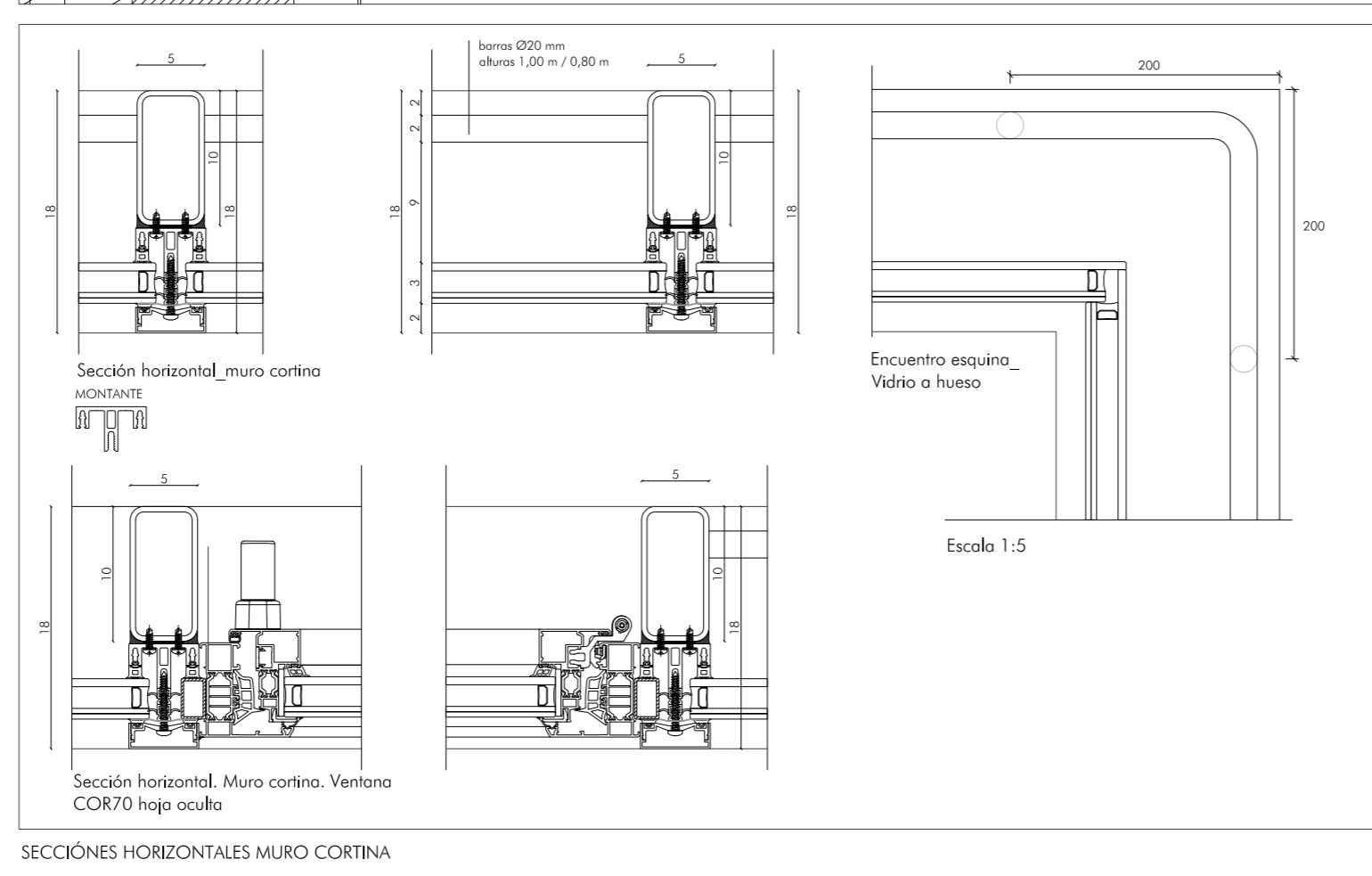
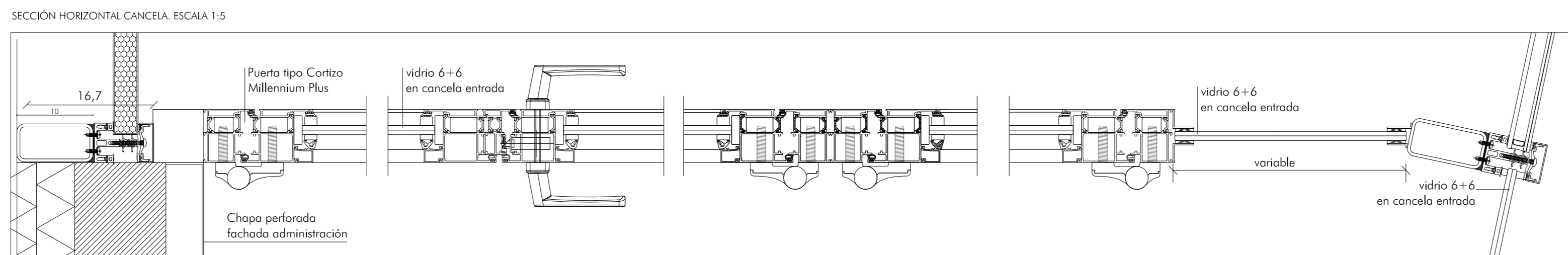

SECCIÓN HORIZONTAL - Salida a cubierta. Escala 1:5

escala 1/100