

ENTRADA DE VEHÍCULOS EN PARCELA

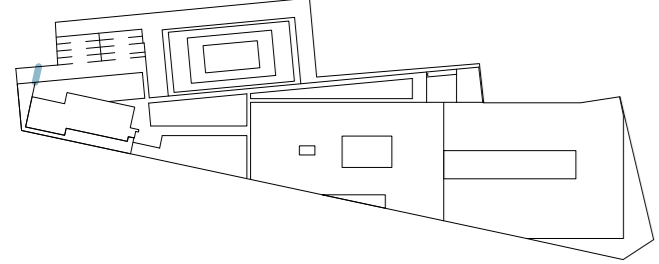

TIPO	PEXT 1
SITUACIÓN	ENTRADA DE VEHICULOS EN LA PARCELA
UNIDADES	1
DIMENSION DEL HUECO	10,28 x 2,34
	ACERO PINTADO

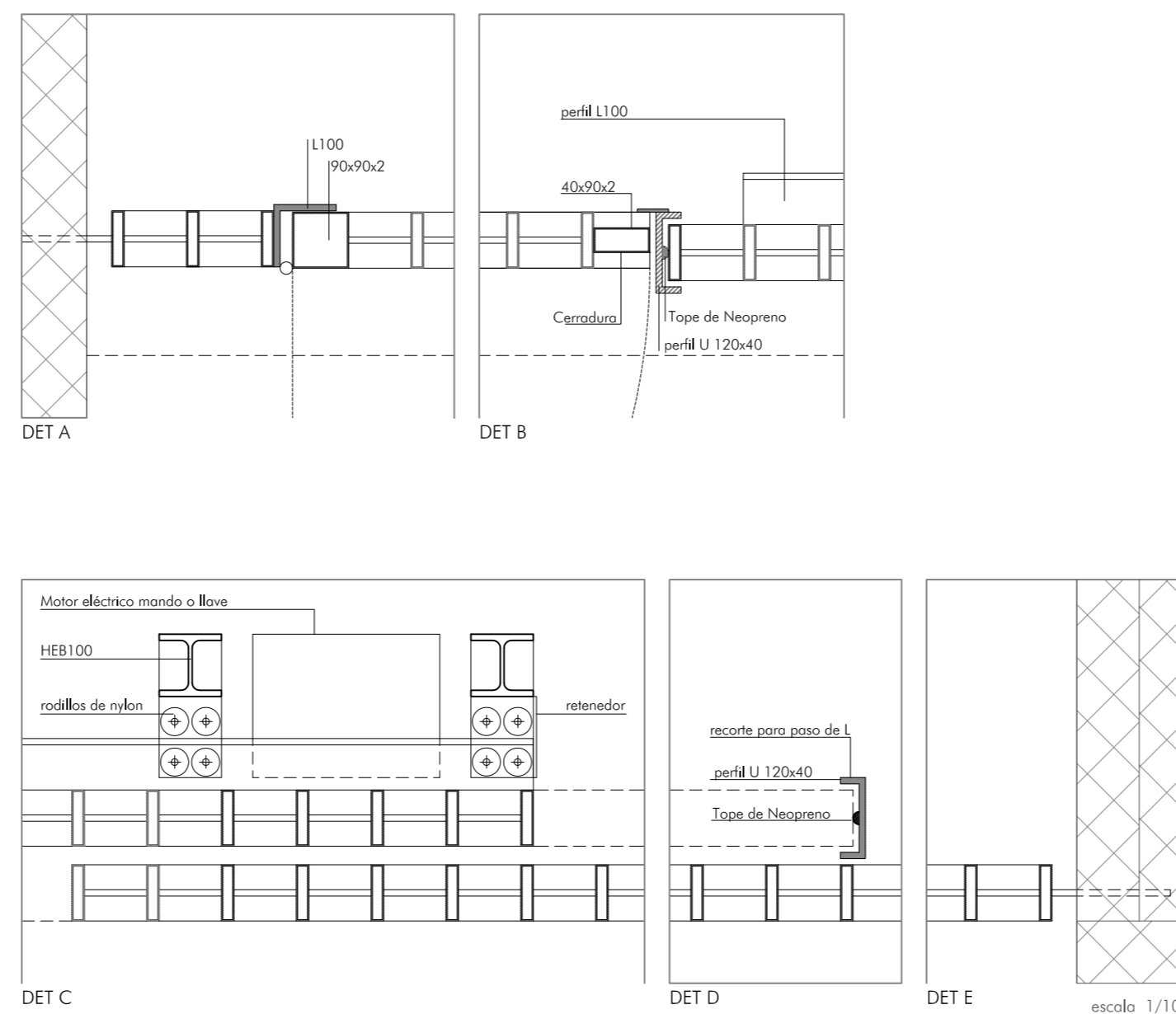
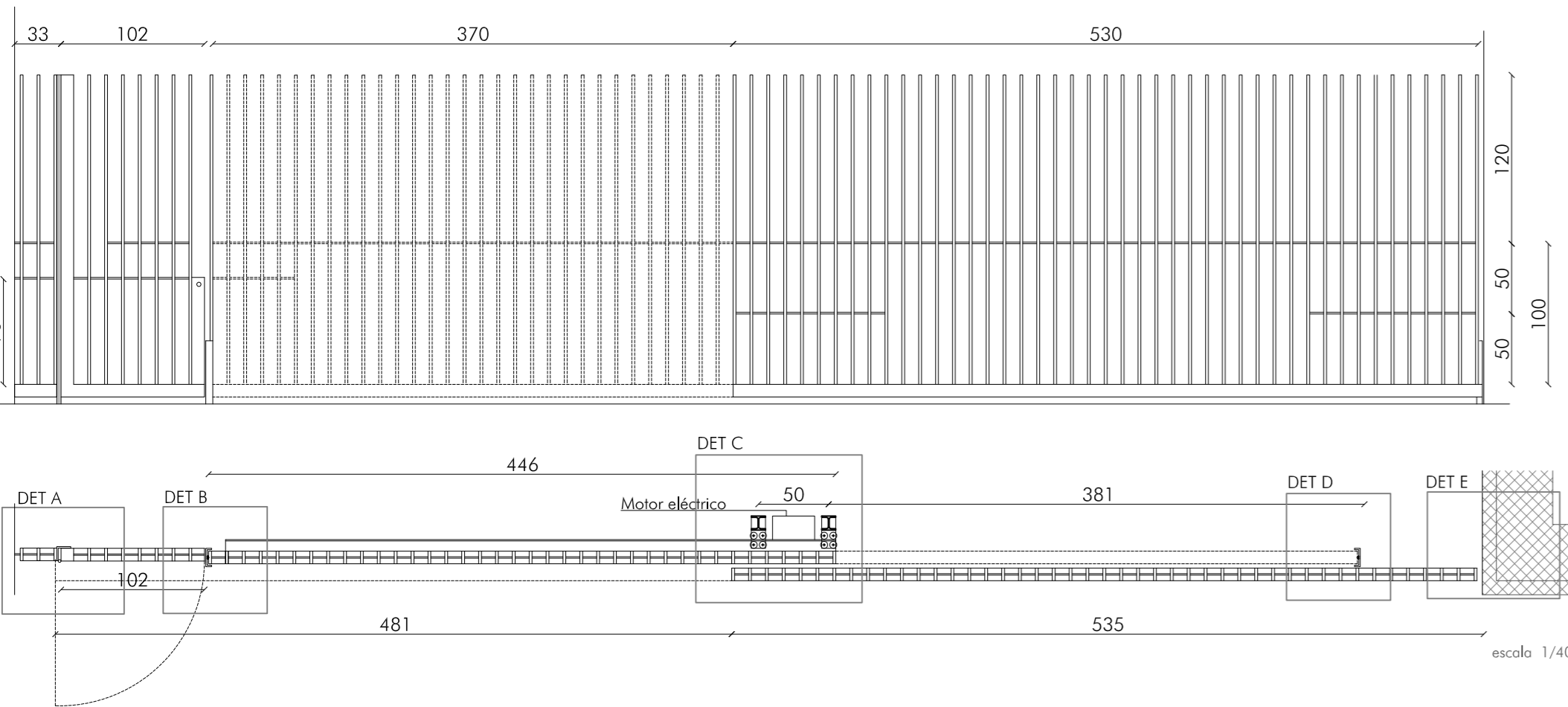

PAPELERAS ALMENDRADAS

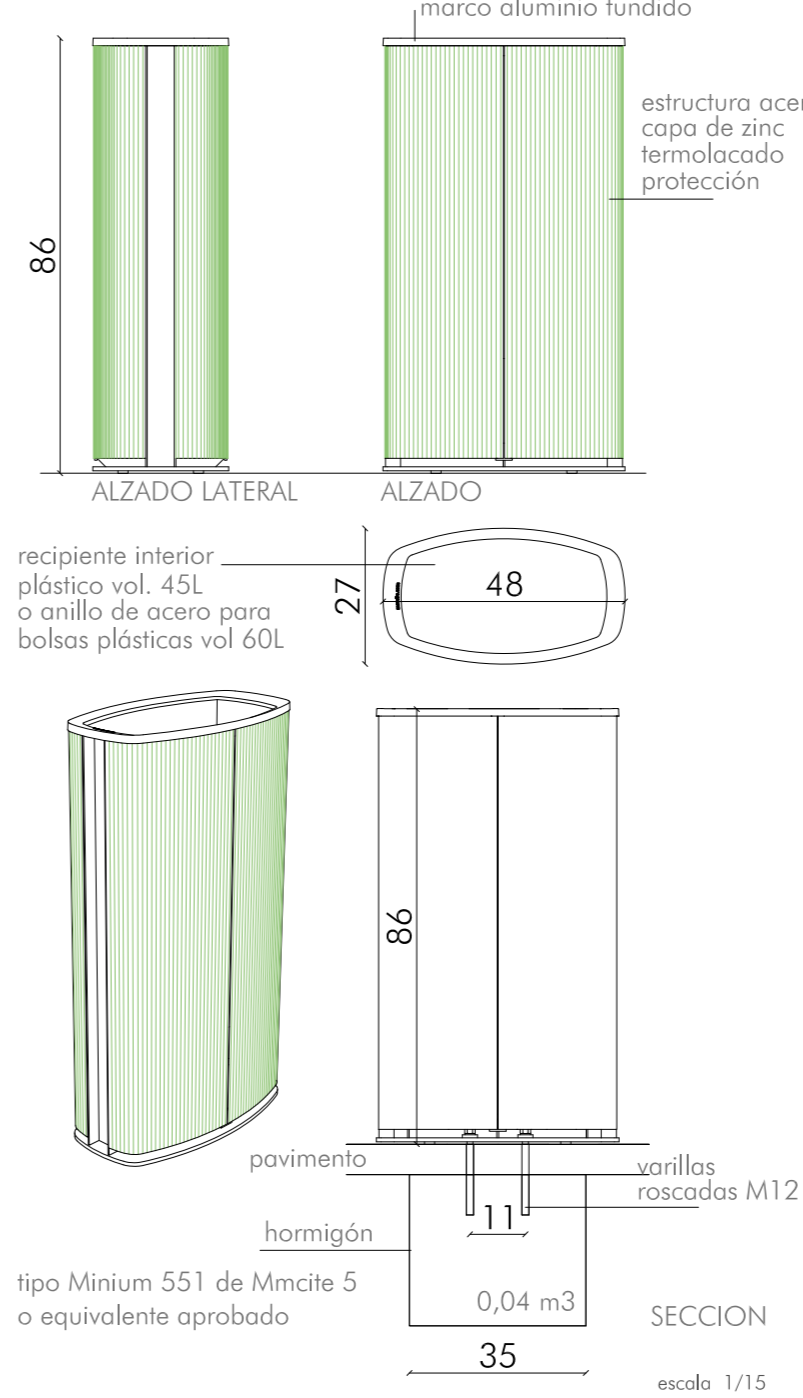

APARCIBILLETAS exterior URBANIZACIÓN

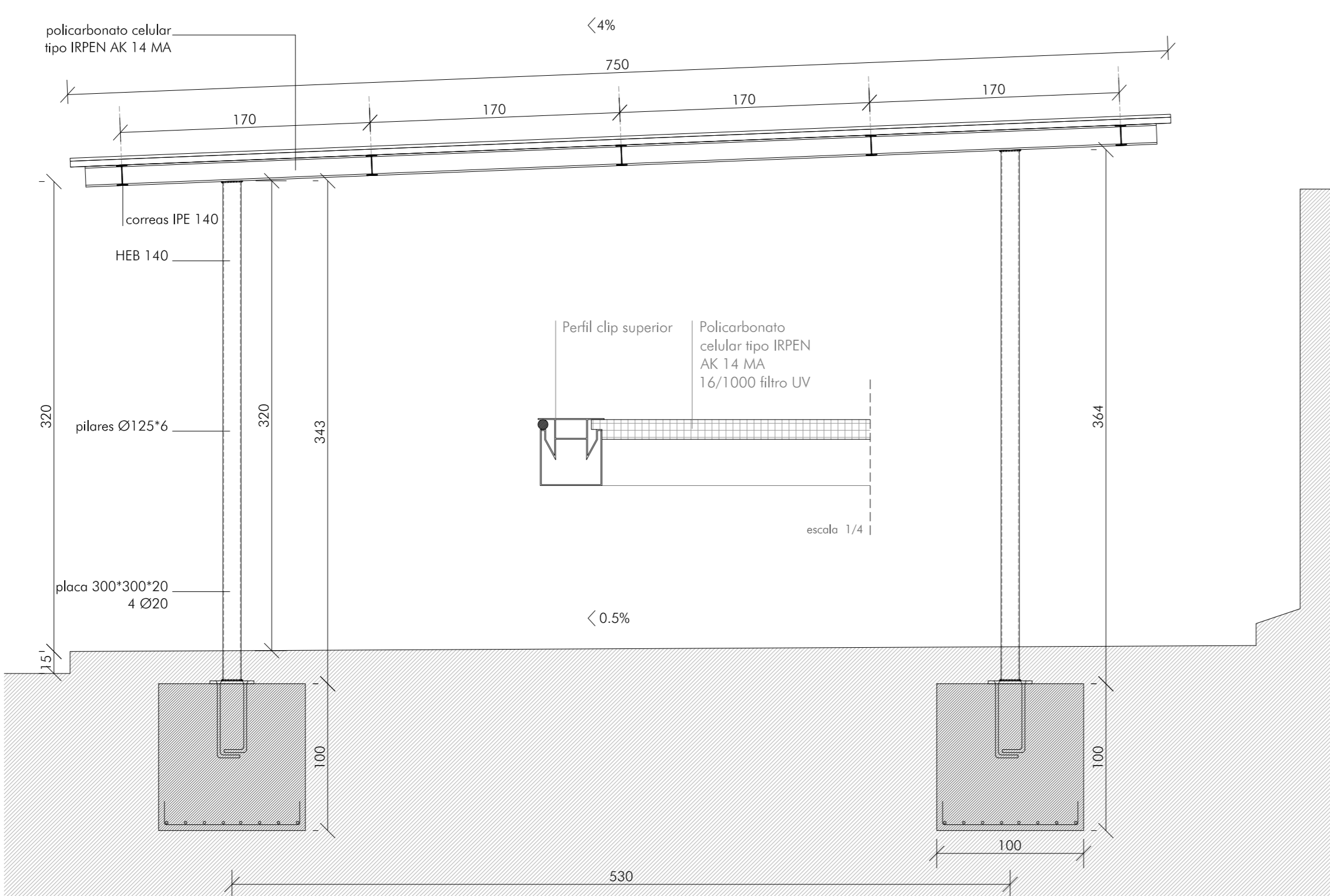
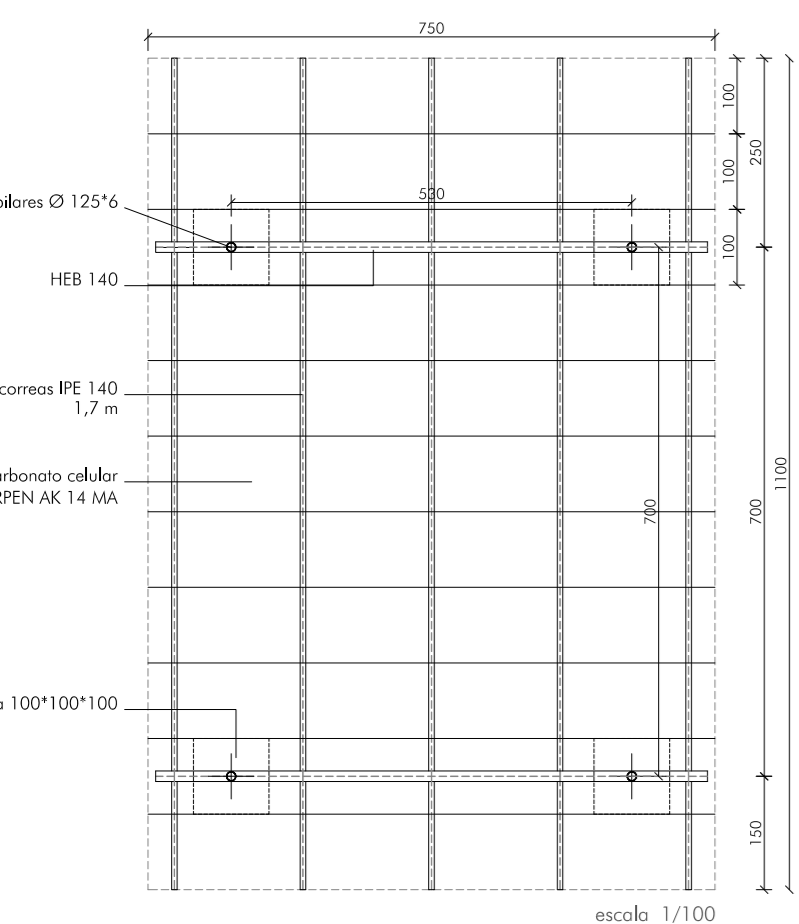
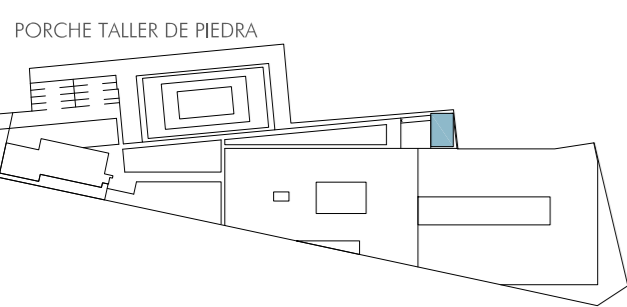
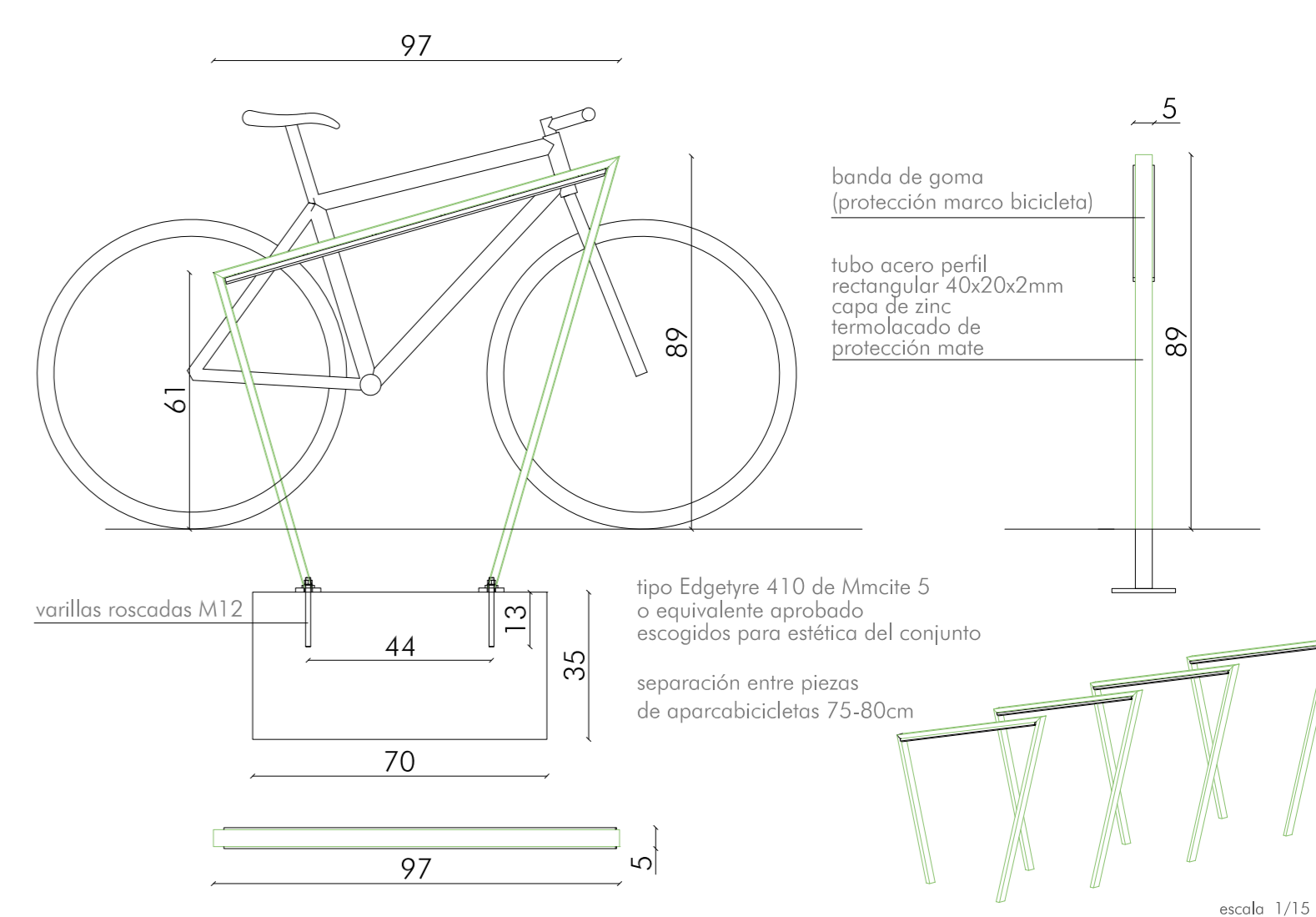

CARACTERÍSTICAS **PLAY** Ⓜ

DISEÑO	Serra del Rocho
MATERIAL	Poliétileno LDPE texturizado
COLOR	negro / gris / caqui / pistacho
BASE	hormigón armado decapado e hidrofugado
GRIFO	pulsador temporizado cromado
TAPA	incorpora llave de paso y sifón
COLOC.	anclada con tornillos / empotrada
PESO	39Kg; Cuerpo 6 Kg / Base 33 Kg

SISTEMA DE COLOCACION

Hormigón después de emplazar

1. surtidor
2. Fuente cuerpo P=6kg
3. Temporizador presto 55
4. Base P= 33kg
5. Casquillos M-10
6. Llave de paso
7. Flexo
8. Puerta registro / 2 tornillos M-6
9. Racor acometida D=1/2"
10. Sifón
11. desagüe tubo PVC Ø125
12. Acometida D=1/2"
13. Mortero rico o resina
14. 2 Casquillos M-12

